

КАТАЛОГ

Аксессуары для держателей инструментов EPPINGER



Архангельск (8182)63-90-72
Астана (7172)727-132
Астрахань (8512)99-46-04
Барнаул (3852)73-04-60
Белгород (4722)40-23-64
Брянск (4832)59-03-52
Владивосток (423)249-28-31
Волгоград (844)278-03-48
Вологда (8172)26-41-59
Воронеж (473)204-51-73
Екатеринбург (343)384-55-89
Иваново (4932)77-34-06

Ижевск (3412)26-03-58
Иркутск (395)279-98-46
Казань (843)206-01-48
Калининград (4012)72-03-81
Калуга (4842)92-23-67
Кемерово (3842)65-04-62
Киров (8332)68-02-04
Краснодар (861)203-40-90
Красноярск (391)204-63-61
Курск (4712)77-13-04
Липецк (4742)52-20-81
Киргизия (996)312-96-26-47

Магнитогорск (3519)55-03-13
Москва (495)268-04-70
Мурманск (8152)59-64-93
Набережные Челны (8552)20-53-41
Нижний Новгород (831)429-08-12
Новокузнецк (3843)20-46-81
Новосибирск (383)227-86-73
Омск (3812)21-46-40
Орел (4862)44-53-42
Оренбург (3532)37-68-04
Пенза (8412)22-31-16
Россия (495)268-04-70

Пермь (342)205-81-47
Ростов-на-Дону (863)308-18-15
Рязань (4912)46-61-64
Самара (846)206-03-16
Санкт-Петербург (812)309-46-40
Саратов (845)249-38-78
Севастополь (8692)22-31-93
Симферополь (3652)67-13-56
Смоленск (4812)29-41-54
Сочи (862)225-72-31
Ставрополь (8652)20-65-13
Казахстан (772)734-952-31

Сургут (3462)77-98-35
Тверь (4822)63-31-35
Томск (3822)98-41-53
Тула (4872)74-02-29
Тюмень (3452)66-21-18
Ульяновск (8422)24-23-59
Уфа (347)229-48-12
Хабаровск (4212)92-98-04
Челябинск (351)202-03-61
Череповец (8202)49-02-64
Ярославль (4852)69-52-93



Zubehör für Werkzeughalter *Inhaltsverzeichnis*

Accessories for Tool Holder · Index

Übersicht / Overview		Gruppe Group	Beschreibung / Description
	Gewindebohrzangen Tapping Collets	Z1.1	Gewindebohrzangen mit Längsausgleich auf Zug
		Z1.2	Gewindebohrzangen ohne Längsausgleich
	Spannzangen Collets	Z2.1	Spannzangen DIN 6499 Schaublin
		Z2.1	Spannzangen DIN 6388 Ortlieb
		Z2.1	Spannzangen DIN 6345 Rubber-Flex
		Z2.2	Spannzangen DIN 6499 Schaublin abgedichtet
	Spannmuttern und Spannschlüssel Collet Nuts And Spanner Wrenches	Z3.1	Spannmuttern mit Innengewinde
		Z3.2	Spannmuttern mit Innengewinde für IK-Werkzeuge
		Z3.3	Spannmuttern mit Aussengewinde
		Z3.4	Spannmuttern mit Aussengewinde für IK-Werkzeuge
	Dichtringe Sealing Rings	Z4.1	Dichtring für Spannmuttern mit Innen- und Aussengewinde DIN6499
	Reduzierbuchsen Bushings	Z5.1	Type A Type G Type N Type B Type H Type P Type C Type I Type R Type D Type K Type S Type E Type L Type F Type M



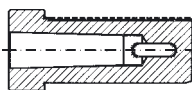
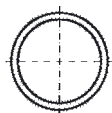
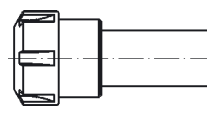
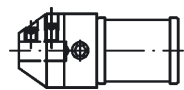
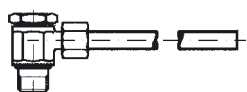

Zubehör für Werkzeughalter *Inhaltsverzeichnis*

Accessories for Tool Holder · Index

Übersicht / Overview	Gruppe Group	Beschreibung / Description
 <p>Reduzierhülsen Tapper Sleeves</p>	Z 6.1	Reduzierhülsen mit Morsekegel
 <p>O-Ringe Sealing Rings</p>	Z 7.1	O-Ringe
 <p>Spannzangenfutter Collet Chucks</p>	Z 8.1	Spannzangenfutter mit Zylinderschaft
 <p>Nutstosshalter Shaping Tool</p>	Z 8.2	Nutstosshalter mit Zylinderschaft
 <p>Kühlmittelzuführungen Coolant Supply</p>	Z 9.1 Z 9.2 Z 9.3	Rohrverschraubungen Kugeldüsen / Verschlussstücke / Rohr (M6) Ringdüsen / Verlängerung
 <p>Mitnehmer Drivers</p>	Z 10.1	Mitnehmer für Gewindebohrer

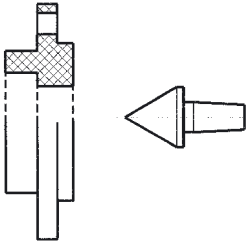
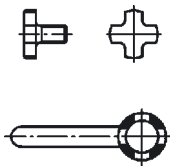
Zubehör für Werkzeughalter *Inhaltsverzeichnis*

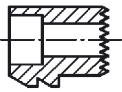
Accessories for Tool Holder · Index

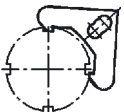
Übersicht / Overview	Gruppe Group	Beschreibung / Description
 <p>Unterlegplatten Adapter</p>	Z 11.1	Unterlegplatten für kleinere Drehmeissel
 <p>Einsätze Inserts</p>	Z 12.1 Z 12.2	Einsätze für Schneideisenhalter Zentriereinsätze für Zentrierspitze
 <p>Fräszubehör Milling Accessories</p>  <p>Backen Jaws</p> 	Z 14.1 Z 14.1 Z 14.1 Z 14.1	Fräseranzugschraube Schlüssel für Fräseranzugschraube Mitnehmerringe für Aufsteckfräserdorne Satz Backen für Greiferfutter
 <p>Spannschlüssel Spanner Wrenches</p>  <p>Doppel-Hakenschlüssel Double Hook Wrench</p>	Z 15.1 Z 15.2	Spannschlüssel für Werkzeughalterspindel Doppel-Hakenschlüssel für Werkzeughalterspindel

Zubehör für Werkzeughalter *Inhaltsverzeichnis*

Accessories for Tool Holder · Index

Übersicht / Overview

**Gruppe
Group**

Beschreibung / Description

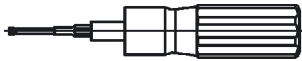
**Z 16.1**Drehmomentschraubendreher
Capto

Zubehör für Werkzeughalter *Inhaltsverzeichnis*

Accessories for Tool Holder · Index

Übersicht / Overview

Gruppe
Group

Beschreibung / Description

Gewindebohrzangen mit Längenausgleich auf Zug (PCM)

Tapping Collets with Tension Compensation (PCM)

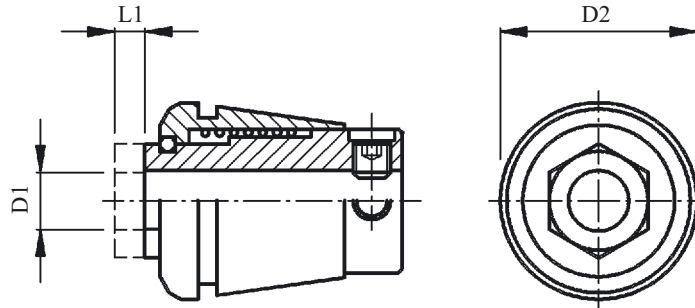

Einh.Nr. Standard No.	426 E	428 E	430 E	470 E	472 E	474 E
Nenngröße DIN term	ER 16	ER 20	ER 25	ER 32	ER 40	ER 50
D2	17	21	26	33	41	51
L1	7	7	7	9	13	20

D1	Artikel-Nr. Part No.	Artikel-Nr. Part No.	Artikel-Nr. Part No.	Artikel-Nr. Part No.	Artikel-Nr. Part No.	Artikel-Nr. Part No.
2,5	218.786.025	218.785.025	-	-	-	-
2,8	218.786.028	218.785.028	218.784.028	-	-	-
3,5	218.786.035	218.785.035	218.784.035	-	-	-
4	218.786.040	218.785.040	218.784.040	-	-	-
4,5	218.786.045	218.785.045	218.784.045	218.783.045	-	-
6	-	218.785.060	218.784.060	218.783.060	218.770.220	-
6,3	-	218.785.063	218.784.063	218.783.063	218.771.220	-
7	-	218.785.070	218.784.070	218.783.070	218.772.220	-
8	-	-	218.784.080	218.783.080	218.773.220	-
9	-	-	218.784.090	218.783.090	218.774.220	218.808.090
10	-	-	218.784.100	218.783.100	218.775.220	-
11	-	-	-	218.783.110	218.776.220	-
11,2	-	-	-	-	218.777.220	-
12	-	-	-	218.783.120	218.778.220	218.808.120
12,5	-	-	-	-	218.779.220	-
14	-	-	-	-	218.780.220	218.808.140
16	-	-	-	-	218.781.220	-
18	-	-	-	-	-	218.808.180

Gewindebohrzangen ohne Längenausgleich

Tapping Collets without Axial Compensation

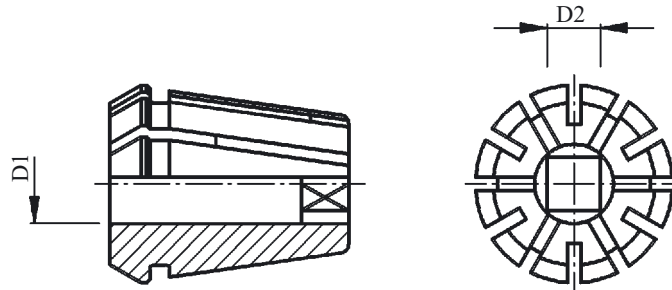

Type	428 E	430 E	470 E	472 E	474 E	für Gewindebohrer nach for Tappers acc.
Einh.-Nr. Standard No.	ER 20-GB	ER 25-GB	ER 32-GB	ER 40-GB	ER 50-GB	

D1 Ø	D2 □	Artikel-Nr. Part No.	Artikel-Nr. Part No.	Artikel-Nr. Part No.	Artikel-Nr. Part No.	Artikel-Nr. Part No.	DIN 371	DIN 374	DIN 376
4,5	3,4	218.795.045	218.796.045	218.797.045	-		M4	M6	M6
5,5	4,3	218.795.055	218.796.055	218.797.055	-		-	M7	M7
6	4,9	218.795.060	218.796.060	218.797.060	-		M4,5 M5 M6	M8	M8
7	5,5	218.795.070	218.796.070	218.797.070	218.798.070		M7	M9, M10	M9, M10
8	6,2	218.795.080	218.796.080	218.797.080	218.798.080		M8	M11	M11
9	7	218.795.090	218.796.090	218.797.090	218.798.090		M9	M12	M12
10	8	218.795.100	218.796.100	218.797.100	218.798.100		M10	-	-
11	9	-	218.796.110	218.797.110	218.798.110		-	M14	M14
12	9	-	218.796.120	218.797.120	218.798.120		M12	M16	M16
14	11	-	-	218.797.140	218.798.140		-	M18	M18
16	12	-	-	218.797.160	218.798.160		-	M20	M20
18	14,5	-	-	-	218.798.180		-	M22, M24	M22, M24
20	16	-	-	-	218.798.200		-	M27	M27

Spannzangen

Collets

DIN 6499-B doppelseitig geschlitzt (Schaublin)

ER Nenngröße DIN term	Einh.-Nr. Standard No.	Spann- bereich Range	D1*	steigend um mm increasing by	Artikel-Nr. Part No.
ER 8	4004 E	0,5-5	1; ...; 5	0,5	218.585. __
ER 11	4008 E	0,5-7	1; ...; 7	0,5	218.595. __
ER 16	426 E	0,5-10	1; 2; ...; 10	0,5 1	218.605. __
ER 20	428 E	1 - 13	1; 1,5; 2; ...; 13	0,5 1	218.615. __
ER 25	430 E	1 - 16	1; 1,5; 2; ...; 16	0,5 1	218.600. __
ER 32	470 E	2 - 20	2; 2,5; 3; ...; 20	0,5 1	218.690. __
ER 40	472 E	3 - 26	3; 3,5; 4; ...; 26	0,5 1	218.610. __
ER 50	474 E	10 - 34	12; ...; 34	2	218.807. __

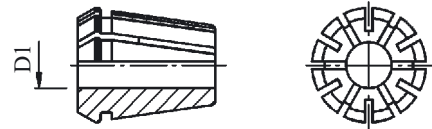

Bemerkung

__ Bei Bestellung bitte Spanndurchmesser angeben.

Bestellbeispiel: Spannzange 470 E, Spanndurchmesser = 16,0 mm : **218.690.160**

* größter Spanndurchmesser der jeweiligen Spannzange.

Remarks

__ Please list clamping diameter when ordering.

Example of an order: Collet 470 E, clamping diameter = 16,0 mm : **218.690.160**

* maximum capacity of the corresponding collet.

Spannzangen

Collets

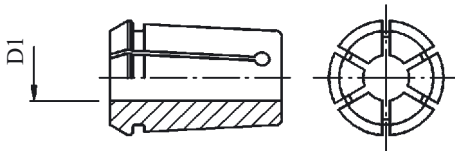

DIN 6388-A einfach geschlitzt (Ortlieb)

Nenngröße DIN term	Einh.-Nr. Standard No.	Spann- bereich Range	D1*	steigend um mm increasing by	Artikel-Nr. Part No.
NG 8	401 E	1 - 8	1,5; ...; 8	0,5	218.505.____
NG 10	404 E	1 - 10	1,5; ...; 10	0,5	218.515.____
NG 12	407 E	1 - 12	1,5; ...; 12	0,5	218.525.____

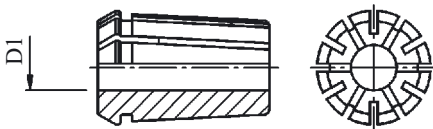

DIN 6388-B doppelseitig geschlitzt (Ortlieb)

Nenngröße DIN term	Einh.-Nr. Standard No.	Spann- bereich Range	D1*	steigend um mm increasing by	Artikel-Nr. Part No.
NG 16	415 E	1,5-16	2; ...; 16	0,5	218.570.____
NG 20	4541 E	1,5-20	2; ...; 20	0,5	218.710.____
NG 25	462 E	1,5-25	2; ...; 25	0,5	218.530.____
NG 32	467 E	3,5-32	4; ...; 32	0,5	218.540.____
NG 40	468 E	7,5-40	8; ...; 40	0,5	218.550.____

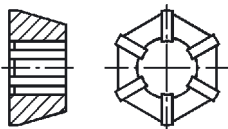

DIN 6345 Rubber Flex

Einh.-Nr. Standard No.	Spannbereich Range	Artikel-Nr. Part No.
J 444	1,8 - 4,5	218.620.220
J 443	2,8 - 7	218.630.220
J 441	4,5 - 10	218.635.220
J 440	7 - 13	218.640.220

Bemerkung

- ___ Bei Bestellung bitte Spanndurchmesser angeben.
- ___ Bestellbeispiel: Spannzange 468 E, Spanndurchmesser = 20,5 mm : 218.550.205
- * größter Spanndurchmesser der jeweiligen Spannzange.

Remarks

- ___ Please list clamping diameter when ordering.
- ___ Example of an order: Collet 468 E, clamping diameter = 20,5 mm : 218.550.205
- * maximum capacity of the corresponding collet.

Spannzangen abgedichtet

Collets with Sealing

DIN 6499 doppelseitig geschlitzt

ER Nenngröße DIN term	Einh.-Nr. Standard No.	Spann- bereich Range	steigend um mm increasing by	Artikel-Nr. Part No.
ER 11	4008 E	3 - 7*	0,5	218.800. __
ER 16	426 E	3 - 10*	1,0	218.801. __
ER 20	428 E	3 - 13*	1,0	218.802. __
ER 25	430 E	3 - 16*	1,0	218.803. __
ER 32	470 E	3 - 20*	1,0	218.804. __
ER 40	472 E	4 - 26*	2,0	218.805. __
ER 50	474 E	12 - 34*	2,0	218.806. __



Bemerkungen

__ Bei Bestellung bitte Spanndurchmesser angeben.

Bestellbeispiel: Spannzange 472 E, Spanndurchmesser = 12,7 mm : **218.805.127**

* **Achtung!** Spanndurchmesser muss Werkzeugdurchmesser sein.

Remarks

__ Please list clamping diameter when ordering.

Example of an order: Collet 472 E, clamping diameter = 12,7 mm : **218.805.127**

* **Important!** clamping and tooling diameter must be identical.

Spannmutter mit Innengewinde und Spannschlüssel

Collet Nuts with Internal Thread, Spanner Wrenches

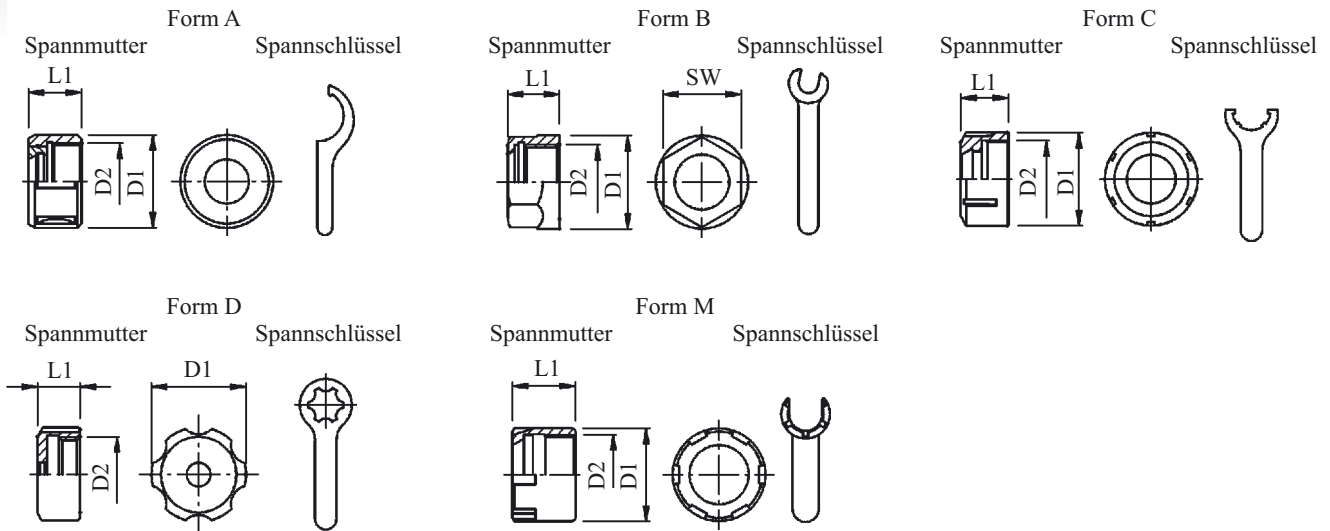

für Spannzangen for Collets			Spannmuttern Collet Nuts				Spannschlüssel Spanner Wrenches		
nach according	Nenngröße DIN term	Einh.-Nr. Standard No.	Bezeichnung Term	D1	L1	D2	Artikel-Nr. Part No.	Form	Artikel-Nr. Part No.
DIN 6388	NG 8	401 E	* OZ 1820	26	19	M20x1,5	10089	A	10002
DIN 6388	NG 10	404 E	* OZ 1821	30	19	M22x1,5	10090	A	10002
DIN 6388	NG 12	407 E	* OZ 1822	35	20	M27x1,5	10091	A	10004
DIN 6388	NG 16	415 E	OZ 1823	43	24	M33x1,5	10084	A	10005
DIN 6388	NG 20	454 E	OZ 1824	50	28	M42x2,0	10088	A	10006
DIN 6388	NG 25	462 E	OZ 1825	60	30	M48x2,0	10085	A	10008
DIN 6388	NG 32	467 E	OZ 1826	72	33,50	M60x2,5	10086	A	10009
DIN 6388	NG 40	468 E	OZ 1827	85	37	M68x2,5	10087	A	10010
DIN 6499	ER 11	424 E	ER 11 6 kt.	19	12	M14x0,75	10098	B	22294 (SW 17)
DIN 6499	ER 16	426 E	ER 16 6 kt.	28	18	M22x1,5	10099	B	13573 (SW 25)
DIN 6499	ER 16	426 E	ER 16/M	22	18	M19x1	10117	M	10022
DIN 6499	ER 20	428 E	ER 20/M	28	19,5	M24x1	12155	M	13797
DIN 6499	ER 20	428 E	ER 20 6 kt.	34	19,5	M25x1,5	10100	B	14793 (SW 30)
DIN 6499	ER 25	430 E	ER 25/M	35	21	M30x1	13116	M	13115
DIN 6499	ER 25	430 E	ER 25	42	21	M32x1,5	10095	C	10011
DIN 6499	ER 32	470 E	ER 32	50	23	M40x1,5	10097	C	10012
DIN 6499	ER 32	470 E	ER 32/GM	50	23	M40x1,5	14389	C	10012
DIN 6499	ER 40	472 E	ER 40	63	28	M50x1,5	10096	C	10013
DIN 6499	ER 40	472 E	ER 40/KM	63	26	M50x1,5	14426	C	10013
DIN 6499	ER 50	474 E	ER 50/GM	78	38,1	M64x2,0	12638	C	12740
DIN 6345 Rubber Flex		J444, J443 J441, J440	OZ 3159	40	18	M32x1,5	10092	D	10016

Bemerkungen / Remarks * einteilige Spannmutter / one part collet nut

Spannmuttern (dichtend) mit Innengewinde und Spannschlüssel für Werkzeuge mit innerer Kühlmittelzufuhr

Collet Nuts (Sealing) with Internal Thread for Tools with Internal Coolant Supply

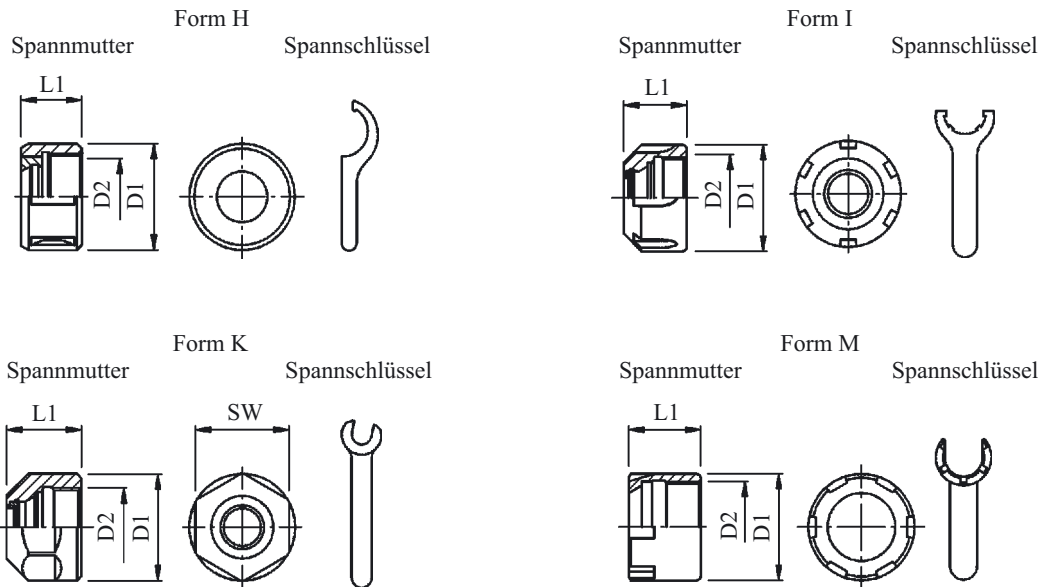

für Spannzangen for Collets			Spannmuttern Collet Nuts						Spannschlüssel Spanner Wrenches	
nach according	Nenngröße DIN term	Einh.-Nr. Standard No.	Bezeichnung Term	Artikel-Nr. Part No.	L1	D1	D2	Form	Artikel-Nr. Part No.	
DIN 6388	NG 16	415 E	OZ 1823	10084 ¹⁾	24	43	M33x1,5	H	10005	
DIN 6388	NG 20	454 E	OZ 1824	10088 ¹⁾	28	50	M42x2,0	H	10006	
DIN 6388	NG 25	462 E	OZ 1825	10085 ¹⁾	30	60	M48x2,0	H	10008	
DIN 6388	NG 32	467 E	OZ 1826	10086 ¹⁾	33,5	72	M60x2,5	H	10009	
DIN 6388	NG 40	468 E	OZ 1827	10087 ¹⁾	37	85	M68x2,5	H	10010	
DIN 6499	ER 25	430 E	ER 25/C	15808	25	42	M32x1,5	I	10011	
DIN 6499	ER 32	470 E	ER 32/C	15810	27,5	50	M40x1,5	I	10012	
DIN 6499	ER 40	472 E	ER 40/C	15811	30,5	63	M50x1,5	I	10013	
DIN 6499	ER 50	474 E	ER 50/GM	12638 ¹⁾	38,1	78	M64x2,0	I	12740	
DIN 6499	ER 11	424 E	ER 11/M	219.090. __ ²⁾	14,6	16	M13x0,75	M	14357	
DIN 6499	ER 16	426 E	ER 16/M	15666	24	22	M19x1,0	M	10022	
DIN 6499	ER 16	426 E	ER 16/C 6 kt.	15805	22,5	28	M22x1,5	K	13573 (SW 25)	
DIN 6499	ER 20	428 E	ER 20/C 6 kt.	15807	24	34	M25x1,5	K	14793 (SW 30)	
DIN 6499	ER 20	428 E	ER 20/M	15667	24	28	M24x1,0	M	13797	
DIN 6499	ER 25	430 E	ER 25/M	15668	27	35	M30x1,0	M	13115	

Bemerkungen / Remarks

¹⁾ Abgedichtete Spannzange verwenden / To use collets with Sealing

²⁾ Dichtung in Spannmutter integriert / Sealing rings for Collet Nuts integrated

Bei Bestellung bitte Durchmesser angeben: Durchmesser 3 mm = 219.090.030 (siehe Z4.1)

Please list clamping diameter when ordering: diameter 3 mm = 219.090.030 (see Z4.1)

Spannmutter mit Aussengewinde und Spannschlüssel

Collet Nuts with External Thread, Spanner Wrenches

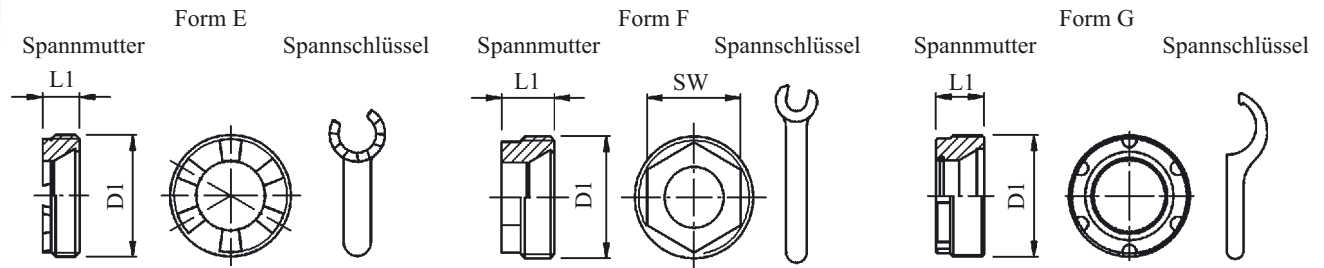

für Spannzangen for Collets			Spannmuttern Collet Nuts					Spannschlüssel Spanner Wrenches	
nach according	Nenngröße DIN term	Einh.-Nr. Standard No.	Bezeichnung Term	Artikel-Nr. Part No.	L1	D1	Form	Artikel-Nr. Part No.	
DIN 6499	ER 11	424 E	ER 11 AX	15386	7,5	M18x1,0	E	15879	
DIN 6499	ER 16	426 E	ER 16 AX	15387	7,6	M24x1,0	E	15497	
DIN 6499	ER 20	428 E	ER 20 AX	15388	8,5	M28x1,5	E	15830	
DIN 6499	ER 25	430 E	ER 25 AX	15389	8,8	M32x1,5	E	15562	
DIN 6499	ER 32	470 E	ER 32 AX	15674	9,8	M40x1,5	E	15672	
DIN 6499	ER 40	472 E	ER 40 AX	16138	11,7	M50x1,5	E	16140	
DIN 6499	ER 11	424 E	ER 11 A 6 kt	12590	8	M18x1,0	F	16143 (SW 13)	
DIN 6499	ER 16	426 E	ER 16 A 6 kt	15806	11	M24x1,0	F	16144 (SW 19)	
DIN 6499	ER 20	428 E	ER 20 A 6 kt	12364	12,5	M28x1,5	F	14701 (SW 22)	
DIN 6499	ER 25	430 E	ER 25 A 6 kt	15809	14	M32x1,5	F	15920 (SW 24)	
DIN 6499	ER 32	470 E	ER 32 A 6 kt	12946	17,7	M40x1,5	F	15687 (SW 32)	
DIN 6499	ER 40	472 E	ER 40 AC	15812	20	M50x1,5	G	10006	
DIN 6499	ER 50	474 E	ER 50 AK	15309	27	M68x1,5	G	10008	

Spannmuttern (dichtend) mit Aussengewinde und Spannschlüssel für Werkzeuge mit innerer Kühlmittelzufuhr

Collet Nuts (Sealing) with External Thread for Tools with Internal Coolant Supply

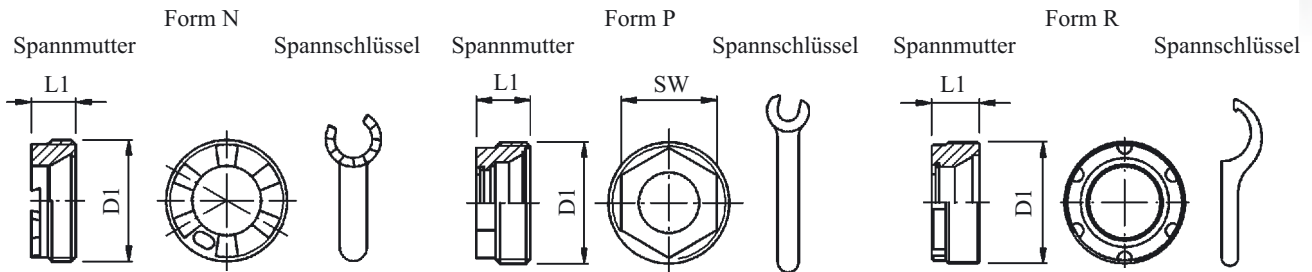

für Spannzangen for Collets			Spannmuttern Collet Nuts					Spannschlüssel Spanner Wrenches
nach according	Nenngröße DIN term	Einh.-Nr. Standard No.	Bezeichnung Term	Artikel-Nr. Part No.	L1	D1	Form	Artikel-Nr. Part No.
DIN 6499	ER 16	426 E	ER 16 AXC	16020	12,5	M24x1	N	15497
DIN 6499	ER 20	428 E	ER 20 AXC	15922	13,5	M28x1,5	N	15830
DIN 6499	ER 25	430 E	ER 25 AXC	15737	13,8	M32x1,5	N	15562
DIN 6499	ER 32	470 E	ER 32 AXC	15626	14,9	M40x1,5	N	15672
DIN 6499	ER 40	472 E	ER 40 AXC	16139	16,6	M50x1,5	N	16140
DIN 6499	ER 16	426 E	ER 16 AC 6 kt.	15806	11	M24x1,0	P	16144 (SW 19)
DIN 6499	ER 20	428 E	ER 20 AC 6 kt.	12364	12,5	M28x1,5	P	14701 (SW 22)
DIN 6499	ER 25	430 E	ER 25 AC 6 kt.	15809	14	M32x1,5	P	15920 (SW 24)
DIN 6499	ER 32	470 E	ER 32 AC 6 kt.	12946	17,7	M40x1,5	P	15687 (SW 32)
DIN 6499	ER 40	472 E	ER 40 AC	15812	20	M50x1,5	R	10006
DIN 6499	ER 50	474 E	ER 50 AC	15309	27	M68x1,5	R	10008

Dichtringe für Spannmutter mit Innen- oder Aussengewinde

Sealing Rings for Collet Nuts with Internal or External Thread

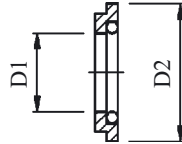

Spannmutter Collet Nuts				Dichtringe Sealing Rings					
nach according		Größe Size	Artikel-Nr. Part No.	Dichtbereich Range	D1 ²⁾	D2	Bezeichnung Term	Artikel-Nr. Part No.	Artikel-Nr. Satz Part No. set
DIN 6499		ER 11 M M13x0,75	219.090. __	2,5 – 7	2,5 ... 7	-	¹⁾	219.090. __	219.090.000
DIN 6499		ER 16 C 6 kt. M22x1,5	15805	2,5 – 10	2,5 ... 10	13	DS/ER 16	219.091. __	219.091.000
DIN 6499		ER 16 M M19x1,0	15666	2,5 – 10	2,5 ... 10	13	DS/ER 16	219.091. __	219.091.000
DIN 6499		ER 16 AC 6 kt. M24x1,0	15806	2,5 – 10	2,5 ... 10	13	DS/ER 16	219.091. __	219.091.000
DIN 6499		ER 20 C 6 kt. M25x1,5	15807	2,5 – 13	2,5 ... 13	16	DS/ER 20	218.713. __	218.713.000
DIN 6499		ER 20 M M24x1,0	15667	2,5 – 13	2,5 ... 13	16	DS/ER 20	218.713. __	218.713.000
DIN 6499		ER 20 AC 6 kt. M28x1,5	12364	2,5 – 13	2,5 ... 13	16	DS/ER 20	218.713. __	218.713.000
DIN 6499		ER 25 C M32x1,5	15808	2,5 – 16	2,5 ... 16	21	DS/ER 25	219.093. __	219.093.000
DIN 6499		ER 25 M M30x1,0	15668	2,5 – 16	2,5 ... 16	21	DS/ER 25	219.093. __	219.093.000
DIN 6499		ER 25 AC 6 kt. M32x1,5	15809	2,5 – 16	2,5 ... 16	21	DS/ER 25	219.093. __	219.093.000
DIN 6499		ER 25 AXC M32x1,5	15737	2,5 – 16	2,5 ... 16	21	DS/ER 25	219.093. __	219.093.000
DIN 6499		ER 32 C M40x1,5	15810	2,5 – 20	2,5 ... 20	27	DS/ER 32	219.094. __	219.094.000
DIN 6499		ER 32 AC 6 kt. M40x1,5	12946	2,5 – 20	2,5 ... 20	27	DS/ER 32	219.094. __	219.094.000
DIN 6499		ER 32 AXC M40x1,5	15626	2,5 – 20	2,5 ... 20	27	DS/ER 32	219.094. __	219.094.000
DIN 6499		ER 40 C M50x1,5	15811	2,5 – 26	2,5 ... 26	33,5	DS/ER 40	219.095. __	219.095.000
DIN 6499		ER 40 AC M50x1,5	15812	2,5 – 26	2,5 ... 26	33,5	DS/ER 40	219.095. __	219.095.000
DIN 6499		ER 50 AC M65x1,5	18878	3,0 – 31	3; 4; .. 31	39,8	DS/ER 50	219.140. __	219.140.000
DIN 6499		ER 50	Abgedichtete Spannzangen verwenden / to use collets with sealing						

Bemerkungen

__ Bei Bestellung bitte Durchmesser angeben. Bestellbeispiel: Dichtring DS/ER 25, Durchmesser D1 = 3 mm : **219.093.030**

¹⁾ Für DIN 6388 Abgedichtete Spannzangen (Typ NG) verwenden

²⁾ Dichtbereich z.B.: 2,5; 3; 3,5; 4; 4,5;

Remarks

__ Please list clamping diameter when ordering. Example of an order: Sealing rings DS/ER 25, diameter D1 = 3 mm : **218.093.030**

¹⁾ For DIN 6388 to use collets (Type NG) with sealing

²⁾ Range Example: 2,5; 3; 3,5; 4; 4,5;

Reduzierbuchsen

Bushing

Ausführung A · Type A

D2	18	25	D2	18 h6	25 h6
L1	26	36	L1	26	36
D1	Artikel-Nr. Part No.	Artikel-Nr. Part No.	D1	Artikel-Nr. Part No.	Artikel-Nr. Part No.
2,2		218.246.220	7	218.854.220	118.237.220
2,5		218.471.220	8	218.855.220	118.238.220
2,8		218.247.220	9	218.856.220	118.239.220
3		218.473.220	10	118.220.220	118.240.220
3,5	218.848.220	218.248.220	11		118.241.220
4	218.849.220	118.234.220	12		118.242.220
4,5	218.850.220	218.249.220	12,5	118.227.220	218.476.220
5	218.851.220	118.235.220	14	118.224.220	118.244.220
5,6	218.852.220	218.474.220	16	118.226.220	118.246.220
6		118.236.220	18		118.248.220
6,3	218.853.220	218.475.220	20		118.250.220

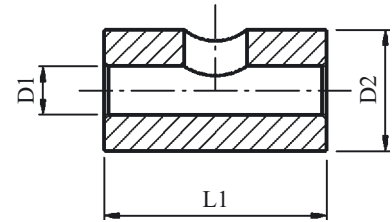

Ausführung B · Type B

D2	32	40
L1	65	72
D1	Artikel-Nr. Part No.	Artikel-Nr. Part No.
8	218.380.220	218.446.220
10	218.381.220	218.447.220
12	218.382.220	218.448.220
16	218.383.220	218.449.220
20	218.384.220	218.450.220
25	218.385.220	218.451.220
30		218.452.220
32		218.453.220

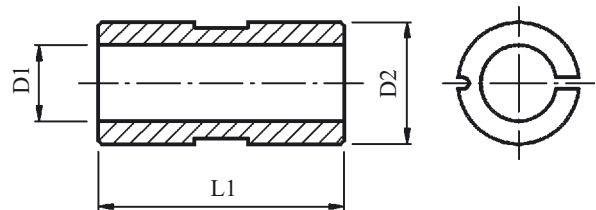

Reduzierbuchsen

Bushing

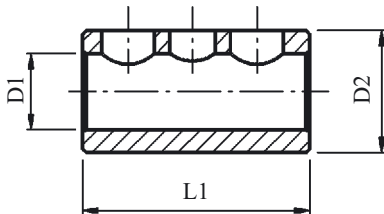

Ausführung C · Type C

D2	32	40	50	32
L1	60	75	85	60
D1	Artikel-Nr. Part No.	Artikel-Nr. Part No.	Artikel-Nr. Part No.	Artikel-Nr. Part No.
6	218.858.220	-	-	-
8	218.862.220	218.868.220	-	-
10	218.863.220	218.869.220	-	-
12	218.864.220	218.870.220	-	-
16	218.865.220	218.871.220	-	-
20	218.866.220	218.872.220	-	-
25	218.867.220	218.873.220	-	218.882.220
32	-	218.874.220	-	-
40	-	-	-	-

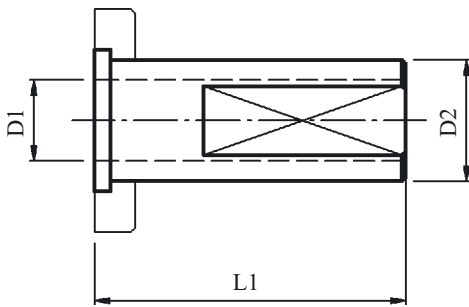

für Verwendung mit Klemmring
DIN 69 880, Form Z1

for Use with Clamping Ring
DIN 69 880, Form Z1

Ausführung D · Type D

D2	20	30	40	50	60
L1	55	77	85	106	88
D1	Artikel-Nr. Part No.	Artikel-Nr. Part No.	Artikel-Nr. Part No.	Artikel-Nr. Part No.	Artikel-Nr. Part No.
Klemmring Clamping Ring	201.020.150	202.020.150	203.030.150	204.040.150	205.020.150
6	211.001.220	-	-	-	-
8	211.002.220	-	-	-	-
10	211.003.220	211.010.220	211.022.220	-	-
12	211.004.220	211.011.220	211.023.220	-	-
16	211.005.220	211.013.220	211.025.220	-	-
20	-	211.014.220	211.026.220	211.029.220	-
25	-	211.015.220	211.027.220	211.030.220	211.033.220
32	-	-	211.028.220	211.031.220	211.034.220
40	-	-	-	211.032.220	211.035.220
50	-	-	-	-	211.036.220

Reduzierbuchsen

Bushing

Ausführung E · Type E

D2	16	25	32	50	1 1/4"
D3	20	30	37	59	37
L1	44	60	60	60	60
L2	3	3	3	5,5	3
D1	Artikel-Nr. Part No.	Artikel-Nr. Part No.	Artikel-Nr. Part No.	Artikel-Nr. Part No.	Artikel-Nr. Part No.
6	-	218.995.220	1012090	-	-
8	-	218.990.220	1012091	-	-
10	7.030.021	218.991.220	1012092	219.070.220	-
12	7.030.020	218.992.220	1012093	219.071.220	-
14	-	-	218.988.220	-	-
16	-	218.993.220	1012094	219.072.220	-
18	-	-	218.989.220	-	-
20	-	218.994.220	1012095	219.073.220	-
25	-	-	1012096	219.074.220	-
32	-	-	-	219.075.220	-
40	-	-	-	219.076.220	-
50	-	-	-	-	-
3/8"	-	-	-	-	218.970.220
1/2"	-	-	-	-	218.971.220
5/8"	-	-	-	-	218.972.220
3/4"	-	-	-	-	218.973.220
1"	-	-	-	-	218.974.220

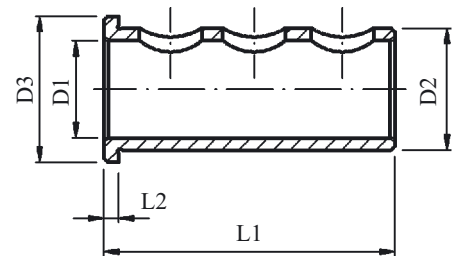

Ausführung F · Type F

D2	16	40	50
L1	36	61	75
D1	Artikel-Nr. Part No.	Artikel-Nr. Part No.	Artikel-Nr. Part No.
6	-	-	-
8	-	219.030.220	-
10	7.040.119	219.031.220	219.020.220
12	-	219.032.220	219.021.220
16	-	219.033.220	219.022.220
20	-	219.034.220	219.023.220
25	-	219.035.220	219.024.220
32	-	219.036.220	219.025.220
40	-	-	219.026.220
50	-	-	-

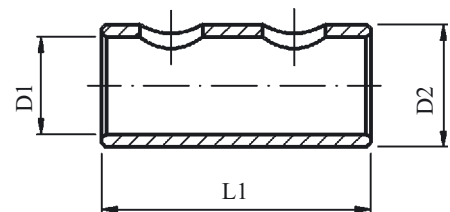

Reduzierbuchsen

Bushing

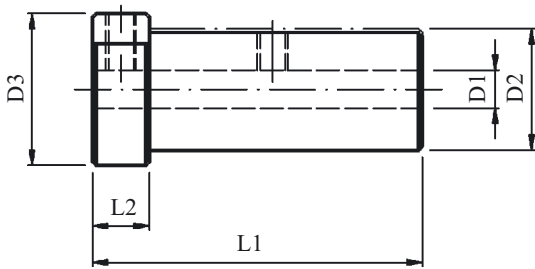

Ausführung G · Type G

D2	32	32
D3	40	40
L1	87	82
L2	15	10
D1	Artikel-Nr. Part No.	Artikel-Nr. Part No.
8	218.945.220	-
10	218.946.220	-
12	218.947.220	-
16	-	218.948.220
20	-	218.949.220
25	-	218.950.220

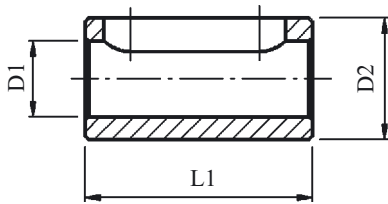

Ausführung H · Type H

D2	32	40	50
L1			85
D1	Artikel-Nr. Part No.	Artikel-Nr. Part No.	Artikel-Nr. Part No.
10	-	-	218.883.220
12	-	-	218.884.220
16	-	-	218.885.220
20	-	-	218.886.220
25	-	-	218.887.220
32	-	-	218.888.220
40	-	-	218.877.220

Reduzierbuchsen

Bushing

Ausführung I · Type I

D2	32	32	
D3	40	40	
L1	79	92	
L2	5	18	
D1	Artikel-Nr. Part No.	Artikel-Nr. Part No.	
16	218.953.220	-	
20	218.954.220	-	
25	-	218.955.220	

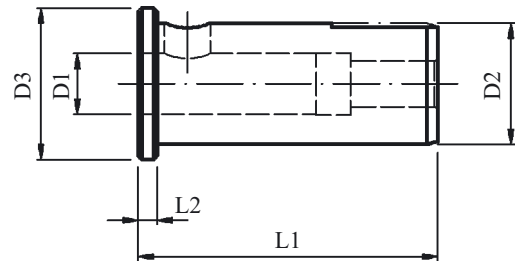

Ausführung K · Type K

D2	1 1/4"	D2	1 1/2"
L1	60	L1	85
D1	Artikel-Nr. Part No.	D1	Artikel-Nr. Part No.
-	-	6	-
3/8"	218.927.220	8	218.920.220
1/2"	218.928.220	10	218.921.220
5/8"	218.929.220	12	218.922.220
3/4"	218.930.220	16	218.923.220
7/8"	218.931.220	20	218.924.220
1"	218.932.220	25	218.925.220
-	-	32	218.926.220
-	-	40	-

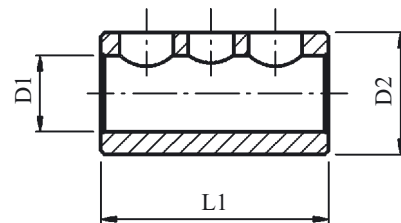

Reduzierbuchsen

Bushing

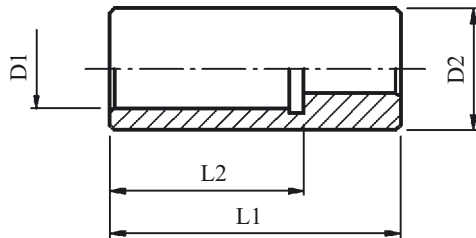

Ausführung L · Type L

Spann-Ø D1	Artikel-Nr. Part No.	D2	L1	L2
16	218.242.220	25	60	42
20	218.241.220	25	60	40

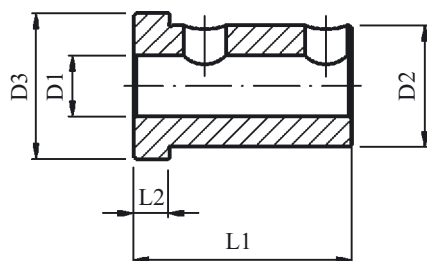

Ausführung M · Type M

D2	40	40
D3	48	48
L1	72	88
L2	12	10
D1	Artikel-Nr. Part No.	Artikel-Nr. Part No.
8	219.050.220*	219.010.220
10	219.051.220	219.011.220
12	219.052.220	219.012.220
16	219.053.220	219.013.220
20	219.054.220	219.014.220
25	219.055.220	219.015.220
32	219.056.220	219.016.220

* Reduzierbuchse vorgezogen – stimmt nicht mit der Zeichnung überein.

Reduzierbuchsen

Bushing

Ausführung N · Type N

D2	25	40	40
D3	29	44	44
L1	50	58	73,5
L2	4	5	8
D1	Artikel-Nr. Part No.	Artikel-Nr. Part No.	Artikel-Nr. Part No.
8	-	-	219.130.220
10	-	-	219.131.220
12	-	-	219.132.220
16	219.114.220	219.103.220	219.133.220
20	219.115.220	219.104.220	219.134.220
25	-	219.105.220	219.135.220
32	-	219.106.220	219.136.220

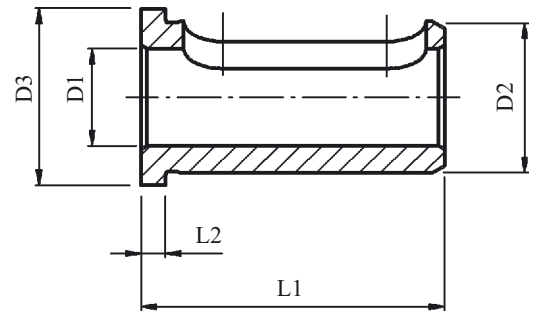

Ausführung P · Type P

D2	25	40
D3	29	44
L1	50	58
L2	4	5
D1	Artikel-Nr. Part No.	Artikel-Nr. Part No.
6	219.110.220	-
8	219.111.220	219.100.220
10	219.112.220	219.101.220
12	219.113.220	219.102.220

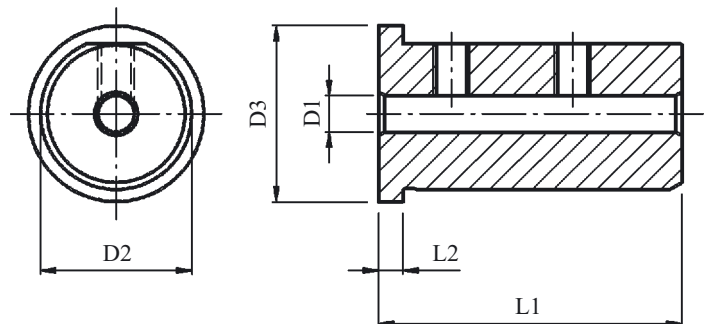

Reduzierbuchsen

Bushing

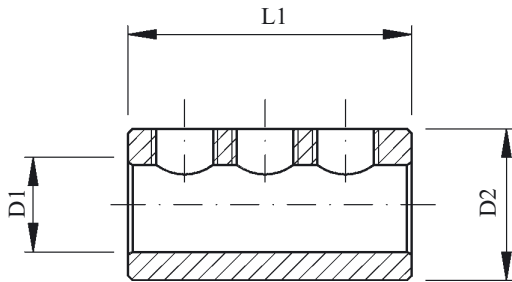
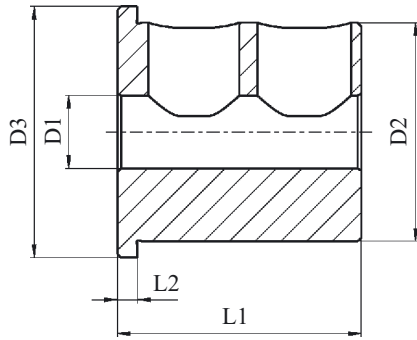

Ausführung R · Type R

D2	60	
D3	69	
L1	67	
L2	5,5	
D1	Artikel-Nr. Part No.	
10	219.080.220	
12	219.081.220	
16	219.082.220	
20	219.083.220	
25	219.084.220	
32	219.085.220	
40	219.086.220	
50	219.087.220	

Ausführung S · Type S

D2	80	
L1	130	
D1	Artikel-Nr. Part No.	
25	219.163.220	
32	219.164.220	
40	219.165.220	
50	219.166.220	
60	219.167.220	

Reduzierhülse mit Morsekegel

Taper Sleeves with Morse Taper

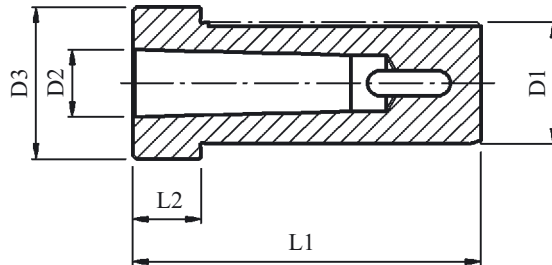

D1	(D2) MK-DK	L1	Artikel-Nr. Part No.	Klemmring Form Z1 Clamping Ring Form Z1	D3	L2
30	1	76	202.151.220	202.020.150		
30	2	77	212.000.220	202.020.150		
30	3	90	212.161.220	202.020.150		
32	1	79	218.951.220	-	40	5
32	2	92	218.952.220	-	40	18
32	3	112	218.956.220	-	40	38
40	1	115	213.024.220	203.030.150		
40	2	95	223.025.220	203.030.150		
40	3	90	213.030.220	203.030.150		
40	4	115	213.035.220	203.030.150		
40	1	79	219.057.220	-	48	9
40	2	92	219.058.220	-	48	22
40	3	112	219.059.220	-	48	42
50	2	118	214.040.220	204.040.150		
50	3	118	214.045.220	204.040.150		
50	4	118	214.050.220	204.040.150		
60	3	150	215.015.220	205.020.150		
60	4	150	215.020.220	205.020.150		
60	5	150	215.025.220	205.020.150		
1 1/4"	1	79	218.957.220	-	40	5
1 1/4"	2	92	218.958.220	-	40	18
1 1/4"	3	112	218.959.220	-	40	38

O-Ring

Sealing Ring

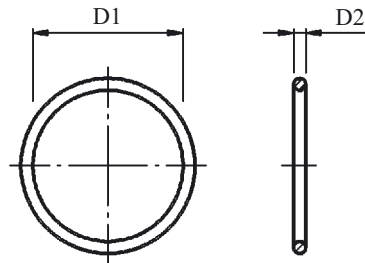

Für Schaft-Ø for Shaft-Ø	Artikel-Nr. Part No.	Abmessung D1 x D2 Dimension D1 x D2
16	11094	Ø15,00 x 1,50
20	11126	Ø18,77 x 1,78
25	11128	Ø23,52 x 1,78
30	11131	Ø28,30 x 1,78
40	11219	Ø37,77 x 2,62
50	11212	Ø47,29 x 2,62
60	11236	Ø56,74 x 3,53

Spannzangenfutter mit Zylinderschaft

Collet Chuck with Cylindrical Shank

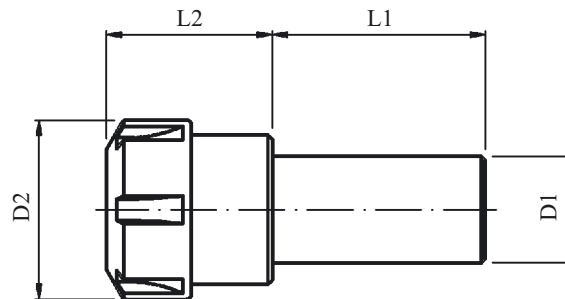

D1	Für Spannzangen for Collets			Artikel-Nr. Part No.	D2	L1	L2
	Spannbereich Range	Nenngröße DIN term	nach according				
25	0,5 - 16	ER 25	DIN 6499	218.944.220	42	50	39
32	0,5 - 16	ER 25	DIN 6499	218.942.220	42	75	20
32	1,5 - 20	ER 32	DIN 6499	218.943.220	50	60	39
32	3,0 - 26	ER 40	DIN 6499	218.939.220	63	60	39
40	1,5 - 20	ER 32	DIN 6499	218.940.220	50	80	25
40	3,0 - 26	ER 40	DIN 6499	218.941.220	63	75	37

Bemerkungen / Remarks Spannmutter siehe Z 3.1 Form C / Collet Nut see Z 3.1 Type C

Nutstosshalter mit Zylinderschaft

Shaping Tool with Cylindrical Shank

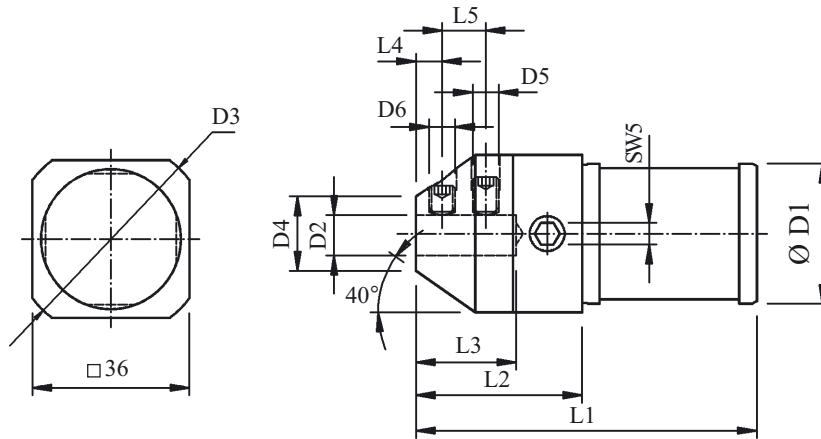

Größe/Size D1	Artikel-Nr. Part No.	D2	D3	D4	D5	D6	L1	L2	L3	L4	L5
32	7.030.675	7	45	10	M5x8	M5x6	80	40	25	6	10
32	7.030.670	10	45	17	M6x8	M6x6	78	38	23	6	10

Rohrverschraubungen

Coolant Tubes

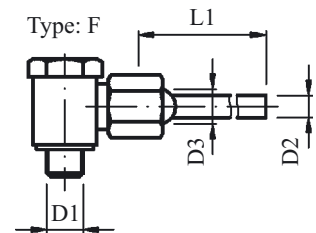
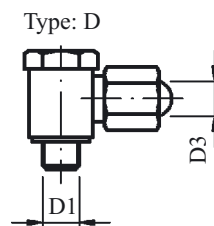
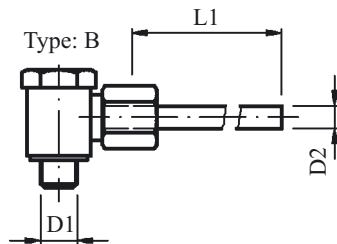
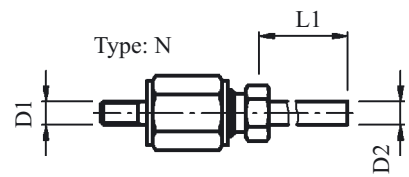
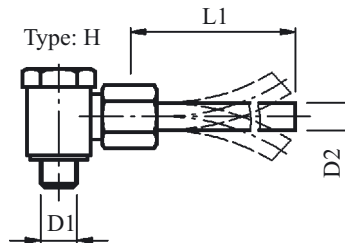
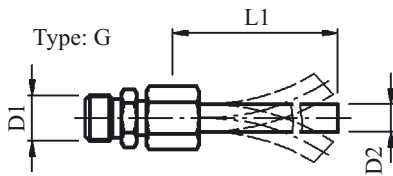
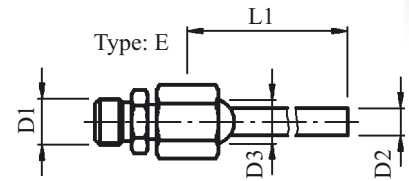
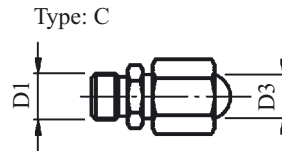
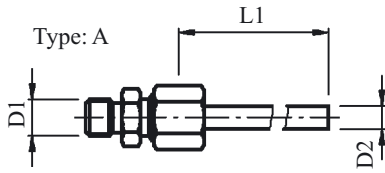

D1	Type Type	D2	D3 Kugeldüse Nozzle	L1	Artikel-Nr. Part No.
M 8x1	A	Ø6	-	90	218.844.220
M 8x1	B	Ø5	-	60	218.845.220
M 8x1	G	Ø6 (flex. Rohr)	-	100	0.000.398
M 8x1	H	Ø6 (flex. Rohr)	-	100	0.000.400
M 10x1	A	Ø6	-	90	218.469.220
M 10x1	B	Ø6	-	90	218.468.220
M 10x1	G	Ø6 (flex. Rohr)	-	100	0.000.407
M 10x1	H	Ø6 (flex. Rohr)	-	100	0.000.412
M 10x1	A	Ø8	-	100	218.445.220
M 10x1	B	Ø8	-	100	218.460.220
M 10x1	C	-	Ø10 (M 6)	-	218.825.220
M 10x1	D	-	Ø10 (M 6)	-	218.824.220
M 10x1	E	Ø6	Ø10 (M 6)	90	0.000.135
M 10x1	F	Ø6	Ø10 (M 6)	90	0.000.366
M 4	-	Ø4	-	100	0.001.159

Kugeldüsen

Nozzle Unit

Kugel Ball	D1	Artikel-Nr. Part No.	D2	D3 +0,03	L1	L2	L3
Ø8	M 4	218.180.000	5,5	9,88	8	13	2,2
Ø10	M 6	218.181.000	6,8	11,88	10	15	3
Ø12	M 6	218.182.000	6,8	13,88	12	17	4

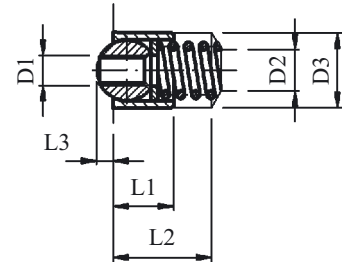

Kugel D1 Ball D1	Type Type	D2	L1	Artikel-Nr. Part No.
Ø12	A	M 5	17,5	7.070.066
Ø12	B	Ø3,5	17,5	7.070.067
Ø15	A	M 6	20	7.070.052
Ø15	B	Ø3,8	20	7.070.053

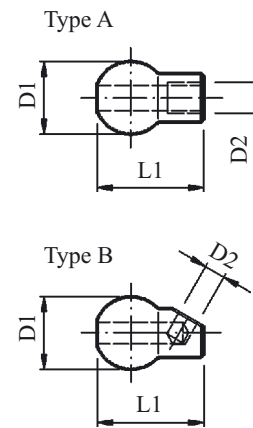

Verschlussstücke

Nozzle Unit

Kugel D1 Ball D1	Artikel-Nr. Part No.	D2	L1
Ø12	7.070.065	M 5	12
Ø15	7.070.051	M 5	17

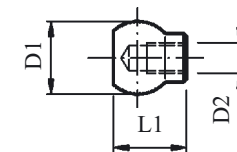

Rohr

Pipe

Rohr D1 Pipe D1	Artikel-Nr. Part No.	L1
Ø6	0.000.490	61,5
Ø6	0.000.134	90

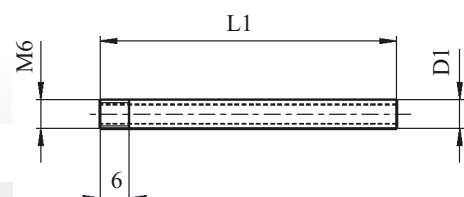

Ringdüsen

Nozzle Unit

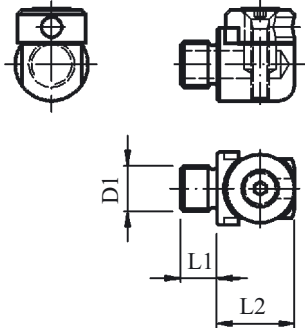

D1	Artikel-Nr. Part No.	L1	L2
M 8x1	0.000.377	8	14
M 10x1	0.000.378	8	17

Verlängerung für Ringdüsen

Nozzle Unit

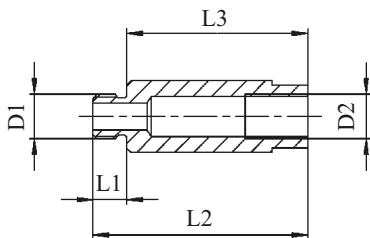

D1	Artikel-Nr. Part No.	L1	L2	L3	D2
M 8x1	7.071.299	10,5	20	9,5	M 8x1
M 8x1	7.071.084	7,5	30	22,5	M 8x1
M 10x1	7.040.524	7,5	32	24,5	M 10x1
M 10x1	7.071.083	7,5	48	40,5	M 10x1

Mitnehmer für Gewindebohrer

Drivers for Tap



	8.010	221.390.220						
	8.011	227.390.220						
	8.206	8.202						
	9.028	8.410						
	9.029	8.411	8.610					
	9.030	8.412	8.611					
	9.031	9.208	9.628					
Für Wkz.-Nr. for Tool No.	9.032	9.209	9.629	222.390.220				für Gewindebohrer nach for Tappers acc.
	9.033	9.428	9.630	223.390.220				
	9.034	9.429	9.631	224.390.220				
	9.035	9.430	9.632					
	9.036	9.431	9.633					
	9.037	9.432	9.634					
	9.225	9.433	9.635					
	9.226	9.434						
	9.436	9.435						
	9.437	9.636						
	9.447	9.637						
	9.448							
□	Artikel-Nr. Part No.	Artikel-Nr. Part No.	Artikel-Nr. Part No.	Artikel-Nr. Part No.	DIN 371	DIN 374	DIN 376	Schaft- Ø Shank Dia.
2,7	0.000.010	0.000.137	0.000.024	-	M 3	M 5	M4,5/M 5	3,5
3	0.000.011	0.000.138	0.000.025	-	M 3,5	-	-	4
3,4	0.000.012	0.000.139	0.000.026	218.826.220	M 4	M 6	M 6	4,5
4,9	0.000.013	0.000.140	0.000.027	218.827.220	M4,5/M5/M6	M 8	M 8	6
5,5	-	0.000.141	0.000.028	218.828.220	M 7	M9/M10	M9/M10	7
6,2	-	0.000.142	0.000.029	218.829.220	M 8	M 11	M 11	8
7	-	-	0.000.030	218.830.220	M 9	M 12	M 12	9
8	-	-	-	218.831.220	M 10	-	-	10
9	-	-	0.000.228	218.832.220	M 12	M14/15/16	M14/M16	12
11	-	-	-	218.833.220	-	M 18	M 18	14
12	-	-	-	218.834.220	-	M 20	M 20	16
Artikel.Nr. Satz Part No. set	0.000.130	0.000.136	0.000.132	218.890.220	-	-	-	-

Unterlegplatten für kleinere Drehmeissel

Adapter for smaller Lathe Chisel

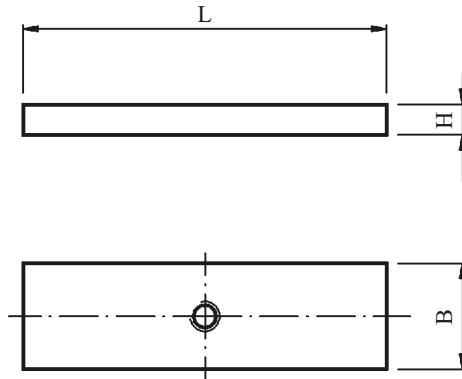

Artikel-Nr. Part No.	H	L	B
218.328.220	4	38	14
218.330.220	4	48	14
218.329.220	4	54	14
218.275.220	4	55	12
218.280.220	4	69	16
218.331.220	4	73	14
218.281.220	4	99	16
218.286.220	5	84	20
218.288.220	5	117	20
218.290.220	7	99	25
218.031.220	7	120	25
218.291.220	7	129	25
218.349.220	7	143	25

Artikel-Nr. Part No.	H	L	B
218.477.220	1/8"	38	14
218.478.220	1/8"	48	14
218.479.220	1/8"	54	14
218.480.220	1/8"	55	12
218.481.220	1/8"	69	16
218.482.220	1/8"	73	14
218.483.220	1/8"	75	12
218.484.220	1/8"	99	16
218.485.220	1/4"	84	20
218.486.220	1/4"	117	20
218.487.220	1/4"	99	25
218.488.220	1/4"	120	25
218.489.220	1/4"	129	25
218.490.220	1/4"	143	25

Einsätze für Schneideisenhalter

Inserts for Extensible Die Holder

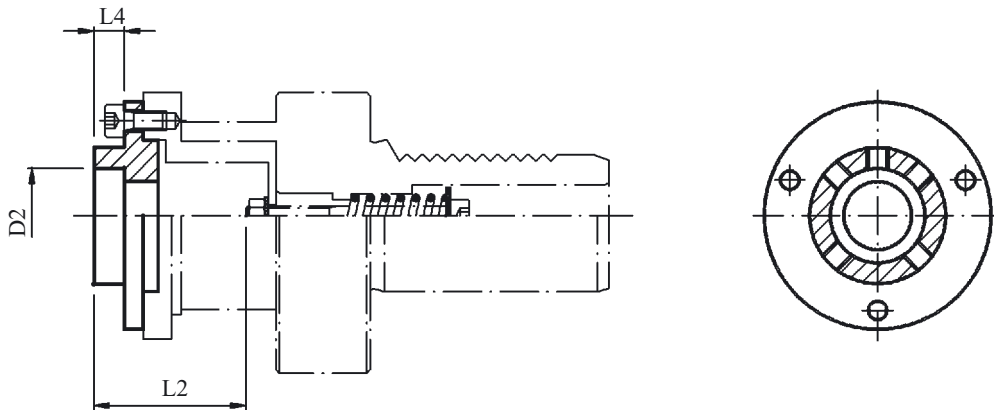

Artikel-Nr. Part No.	Für Gewinde nach DIN 13 for Thread	Für Feingewinde nach DIN 13 for fine Thread	Abmessungen Dimensions		max. Gewindelänge max. Thread Length		
			Aussen- Ø D2	L4	241.335.220 L2	242.335.220 L2	243.335.220 L2
113.406.220	M1 - M2,6	-	16	5	18	-	-
113.408.220	M3 - M4	M3 - M6	20	6	24,2	-	-
113.410.220	M4,5 - M6	M6	20	7	24,2	-	-
113.412.220	M7 - M9	M7 - M9	25	9	26,2	-	-
113.414.220	M10 - M11	M10 - M11	30	11	27,2	-	-
115.406.220	M1 - M2,6	-	16	5	-	37	38
115.408.220	M3 - M4	M3 - M6	20	5	-	37	38
115.410.220	M4,5 - M6	M6	20	7	-	39	40
115.412.220	M7 - M9	M7 - M9	25	9	-	41	42
115.414.220	M10 - M11	M10 - M11	30	11	-	38	39
115.416.220	-	M12 - M14	38	10	-	42	43
115.418.220	M12 - M14	-	38	14	-	46	47
115.436.220	-	M16 - M20	45	14	-	51	52
115.438.220	M16 - M20	-	45	18	-	55	56
115.440.220	-	M22 - M24	55	16	-	53	54
115.442.220	M22 - M24	-	55	22	-	59	60

Zentriereinsätze für Zentrierspitze, mitlaufend

Centering Inserts for Revolving Center Point

Type 1

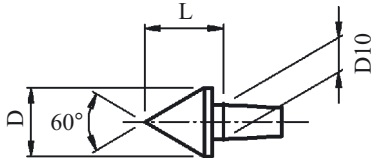

Type 2

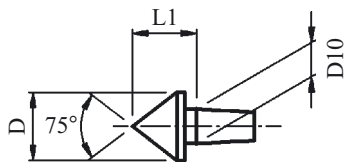

Type 3

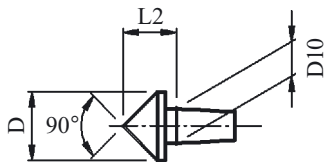

Type 4

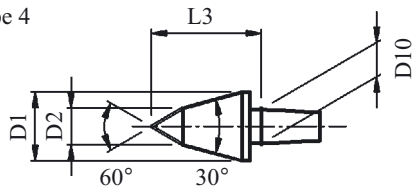

Type 5

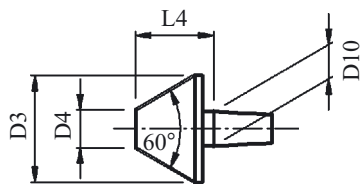

Type 6

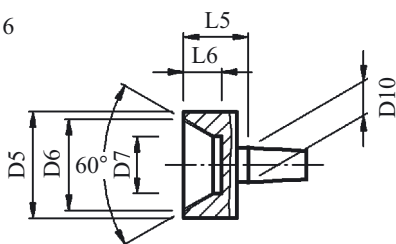

Zentrierspitze
Artikel-Nr.
Part No.
Revolving
Center Point

	241.201.220	242.201.220	243.201.220
Schaft- Ø	20	30	40
D	16	20	24
D1	14	18	18
D2	6	8	8
D3	25	35	45
D4	10	15	25
D5	25	35	45
D6	20	30	40
D7	10	15	25
D10 Kegel 1:10	7	12	12
L	20	24	27,5
L1	17	19,5	22,5
L2	14,5	16,5	19
L3	25	30	30
L4	21	26	27
L5	18	24	25
L6	11	16	16
Type	Artikel-Nr. Part No.	Artikel-Nr. Part No.	Artikel-Nr. Part No.
1	218.916.021	218.916.031	218.916.041
2	218.916.022	218.916.032	218.916.042
3	218.916.023	218.916.033	218.916.043
4	218.916.024	218.916.034	218.916.044
5	218.916.025	218.916.035	218.916.045
6	218.916.026	218.916.036	218.916.046
Austreiber	218.916.020	218.916.030	218.916.040

Fräseranzugsschraube, Schlüssel und Mitnehmerring

Clamping Bolt, Wrench and Driver Ring

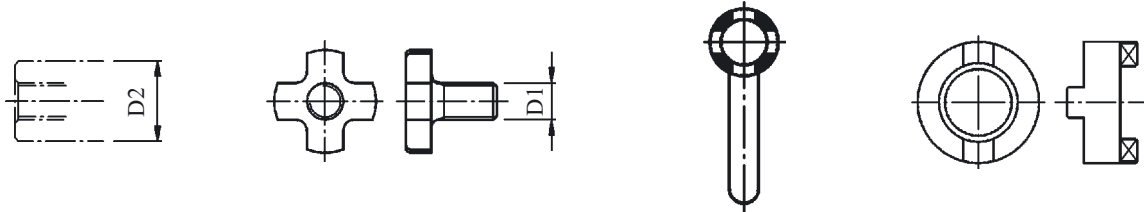

Fräserdornaufnahme DIN 6358 Chuck for Cutter Arbor	Fräseranzugschraube Clamping Bolt		Schlüssel Wrench	Mitnehmerring Driver Ring	
D2	D1	Artikel-Nr. Part No.	Artikel-Nr. Part No.	D3	Artikel-Nr. Part No.
Ø16	M8	11380	10023	Ø16	11376
Ø22	M10	11381	10024	Ø22	11377
Ø27	M12	14416	14451	Ø27	14415
Ø32	M16	11382	10025	Ø32	11378
Ø1/2 "	1/4"- 28 UNF	0.001.029	0.001.032	-	-
Ø3/4 "	3/8"- 24 UNF	0.001.030	10023	-	-
Ø1 "	1/2"- 20 UNF	0.001.031	10024	-	-

Satz Backen für Greiferfutter

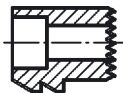

Set Jaw for Bar Puller

Artikel-Nr. Part No.	Stangen- Ø
218.985.220	4 - 20
218.986.220	15 - 68



Spannschlüssel für Werkzeughalterspindel

Spanner Wrenches for Toolholder Spindle

	Artikel-Nr. Part No.		Artikel-Nr. Part No.
16 - 20	12885	45 - 50	10006
20 - 22	13310	52 - 55	10007
25 - 28	10002	58 - 62	10008
30 - 32	10003	68 - 75	10009
34 - 36	10004	80 - 90	10010
40 - 42	10005	95 - 100	15230



	Artikel-Nr. Part No.
40 - 42	0.000.389
45 - 50	0.000.361
45 - 50	0.000.443
45 - 50	0.000.451
52 - 55	0.000.413
52 - 55	0.000.442



	Artikel-Nr. Part No.
52 - 75	0.000.349



Doppel-Hakenschlüssel für Werkzeughalterspindel

Double Hook Wrench for Toolholder Spindle

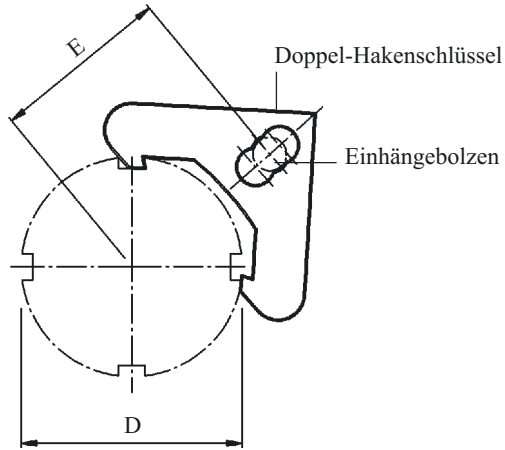

D	E	Artikel-Nr. Part No.
40 - 46	36,4 - 41,8	0.001.071
48 - 60	34,6 - 51,7	0.000.468
62 - 74	43,2 - 60,6	0.000.993
76 - 90	51,7 - 71,0	0.000.994
92 - 98	59,5 - 72,2	0.000.995

Drehmoment-Schraubendreher für Capto

Torque-screwdriver

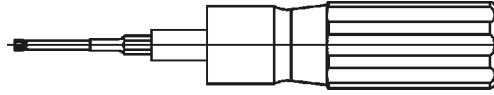

Für angetriebene Werkzeughalter
For Rotary Tool Holders

Größe/Size	Artikel-Nr. Part No.	Nm	TORX
C3	0.001.886	5	T15
C4	0.001.792	9	T20
C5	-		

Архангельск (8182)63-90-72
Астана (7172)727-132
Астрахань (8512)99-46-04
Барнаул (3852)73-04-60
Белгород (4722)40-23-64
Брянск (4832)59-03-52
Владивосток (423)249-28-31
Волгоград (844)278-03-48
Вологда (8172)26-41-59
Воронеж (473)204-51-73
Екатеринбург (343)384-55-89
Иваново (4932)77-34-06

Ижевск (3412)26-03-58
Иркутск (395)279-98-46
Казань (843)206-01-48
Калининград (4012)72-03-81
Калуга (4842)92-23-67
Кемерово (3842)65-04-62
Киров (8332)68-02-04
Краснодар (861)203-40-90
Красноярск (391)204-63-61
Курск (4712)77-13-04
Липецк (4742)52-20-81
Киргизия (996)312-96-26-47

Магнитогорск (3519)55-03-13
Москва (495)268-04-70
Мурманск (8152)59-64-93
Набережные Челны (8552)20-53-41
Нижний Новгород (831)429-08-12
Новокузнецк (3843)20-46-81
Новосибирск (383)227-86-73
Омск (3812)21-46-40
Орел (4862)44-53-42
Оренбург (3532)37-68-04
Пенза (8412)22-31-16
Россия (495)268-04-70

Пермь (342)205-81-47
Ростов-на-Дону (863)308-18-15
Рязань (4912)46-61-64
Самара (846)206-03-16
Санкт-Петербург (812)309-46-40
Саратов (845)249-38-78
Севастополь (8692)22-31-93
Симферополь (3652)67-13-56
Смоленск (4812)29-41-54
Сочи (862)225-72-31
Ставрополь (8652)20-65-13
Казахстан (772)734-952-31

Сургут (3462)77-98-35
Тверь (4822)63-31-35
Томск (3822)98-41-53
Тула (4872)74-02-29
Тюмень (3452)66-21-18
Ульяновск (8422)24-23-59
Уфа (347)229-48-12
Хабаровск (4212)92-98-04
Челябинск (351)202-03-61
Череповец (8202)49-02-64
Ярославль (4852)69-52-93